

Simulation of Cement Grinding Process for Optimal Control of SO₃ Content

D. Tsamatsoulis*

Halyps Building Materials S. A., Italcementi Group,
17th Klm Nat. Rd. Athens – Korinth, 19300, Greece

Original scientific paper
Received: April 25, 2013
Accepted: July 31, 2013

The control of cement grinding/mixing process in an industrial mill regarding SO₃ content has been effectively simulated taking into account all its fundamental sides and particularities. Based on a simulator, two controllers of different philosophy have been studied: A classical proportional-integral (PI) controller as well as a nonlinear one (step changes, SC) consisting of certain classes of SO₃ output ranges that result in certain levels of discrete corrections of gypsum feed. Initially, the simulator was implemented for grinding of a single cement type each time. Totally, three cement types were investigated. The controllers have been parameterized and compared using the minimal standard deviation of SO₃ as a criterion. Both provided satisfactory SO₃ consistency, but PI was more efficient against SC as with the double sampling period, the same minimum standard deviation was obtained leading to equal results with half the sampling actions. The simulation was also realized in milling of several cement types. A feedforward part was added to the feedback loop to face the case of cement type changing. The results of operation of this kind of controller in an industrial milling system contribute greatly to the improvement in cement quality.

Key words:

Regulation, cement, sulphates, dynamics, mill, grinding, uncertainty, simulation

Introduction

Cement is produced by co-grinding clinker, gypsum and other components defined in the Cement Standards like limestone, pozzolans, fly ash and slag. The grinding is usually performed in horizontal ball mills. Gypsum is typically the basic source of sulphates (SO₃) in the cement. The effect of gypsum on the cement quality is critical and two-fold. It affects two of the main properties of this product, setting time and strength.¹ For this reason gypsum is added during cement grinding in the mill feeding, requiring a weight feeder of high accuracy. Clinker is mainly composed of four mineral phases: Tricalcium silicate (3CaO · SiO₂ or C₃S), dicalcium silicate (2CaO · SiO₂ or C₂S), tricalcium aluminate (3CaO · Al₂O₃ or C₃A) and tetracalcium aluminoferrite (4CaO · Al₂O₃ · Fe₂O₃ or C₄AF). Bogue² in an historical study, established the mathematical formulae for the calculation of the clinker compounds – C₃S, C₂S, C₃A, C₄AF – and presented data for the heat of hydration of these compounds. During cement hydration, one of its main mineral phases, tricalcium aluminate, reacts with water at a high rate, which could result in a false set. Gypsum addition slows down this fast and exothermic reaction and false set is prevented during the concrete production, transfer and placing. Conversely, the

addition of an excessive amount of gypsum leads to detrimental expansion of concrete and mortar.

The optimum gypsum content in cement has been investigated by several researchers due to its importance. Lerch,³ in his excellent study, found that the optimum sulphates content in cement, with respect to mortar strength, is closely related to various parameters like hydration heat, length changes of mortar specimens cured in water, alkalis, C₃A content, and cement fineness. The influence of SO₃ on the hydration of the cement mineral phases has been investigated by several researchers.^{3–6} Soroka *et al.*⁴ concluded that gypsum accelerates the rate of hydration, when its addition is below the optimum SO₃ content, but produces significant retardation when the addition exceeds the optimum. Jansen *et al.*⁵ analysed the changes detected in the phase composition during the hydration process. They concluded that the cement phases involved in the aluminate reaction (bassanite, gypsum, anhydrite and C₃A) reacted successively. Several researchers have also investigated the impact of limestone addition to the hydration process and sulphates optimum.^{7–8} Tsamatsoulis *et al.*⁹ determined the effect of cement composition and mortar age on the optimum sulphates content using as criterion the maximization of compressive strength. Extensive experimentation has been performed to achieve this purpose by utilizing four cement types and measuring the strength at ages ranging from 2 days up to

*Corresponding author: e-mail: d.tsamatsoulis@halyps.gr

63 months. The compressive strength is correlated with the ratio of sulphates to clinker content, SO₃/CL. Odler¹⁰ presented a review of existing correlations between cement strength and basic factors related to several properties of the cement and clinker. One of these factors is the sulphates content of the cement. Kheder *et al.*¹¹ found also a significant correlation between strength and cement SO₃ content in their multivariable regression model.

While extensive literature exists about the position of the optimum SO₃ and its relation with several cement characteristics, there is limited information about the regulation of gypsum in the actual production process, so that the values of SO₃ are continuously near the target. Such research is provided by Dhaniel *et al.*¹² by studying the automatic control of cement quality using on-line XRD. Efe¹³ also, by developing a multivariable control of cement mills in the aim to control the process, states that the SO₃ content is one of the main parameters determining to what extent the final product satisfies desired specifications. For the cement industry, it is not sufficient to find the optimum gypsum content in the laboratory: Such research must then be applied to the industrial scale process. The objective of this study is to investigate the control functions for regulation and control of the sulphates content in industrial cement milling. Optimization (i.e. parameter identification) of control functions was performed by simulating the grinding process in cement mill No 6 (CM6) of Halyps plant regarding the sulphates content. Actual analyses of the raw materials had been taken into account, including their uncertainty.

Three cement types conforming to the norm EN 197–1 : 2011 were utilized: CEM A-L 42.5 N, CEM II B-M (P-L) 32.5 N, CEM IV B (P-W) 32.5 N. Their characteristics according to the mentioned norm are provided in Table 1. The results of Tsamatsoulis⁹ models, derived from the same cement types produced in the same plant, were also taken into account to determine the SO₃ target per cement type.

Table 1 – Cement types conforming to EN 197–1:2011

Composition and Strength	CEM Type		
	A-L 42.5 N	B-M (P-L) 32.5 N	IV B (P-W) 32.5 N
%Clinker	≥80	≥65	≥45
%Fly Ash			≤55
%Pozzolane		≤35	
%Limestone	≤20		
Maximum %SO ₃	3.5	3.5	3.5
Minimum 28 days Strength (MPa)	42.5	32.5	32.5

Gypsum is not included in the composition but added according to SO₃ target

Process simulation

The control and regulation of grinding process regarding the SO₃ content is performed by sampling cement in the mill outlet, measuring the SO₃ content, and changing the gypsum percentage in the cement feed composition. The simulation involves all the basic components of the process: The transfer functions of SO₃ within the mill circuit, cement sampling and measurement, and the control function applied. A simplified flow sheet, showing the basic components of a closed grinding system is presented in Fig. 1. The raw materials via weight feeders are fed to the ball mill (CM). The product of the mill outlet is directed through a recycle elevator to a dynamic separator. The high fineness stream of the separator constitutes the final product, while the coarse material returns to CM to be ground again. The block diagram and transfer functions of the grinding process concerning the control of SO₃ content are shown in Fig. 2. The blocks represent the subsequent sub-processes: GP = mixing of materials inside the milling installation; GS = cement sampling; GM = SO₃ measurement; GC = controller. The signals of the feedback

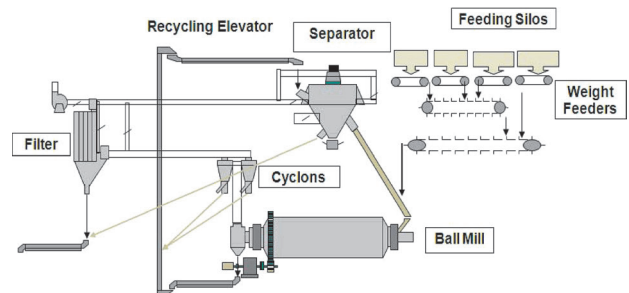

Fig. 1 – Closed circuit grinding system

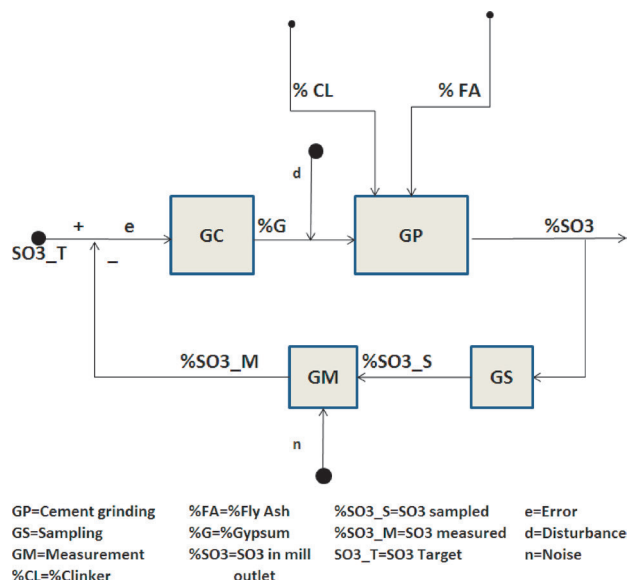

Fig. 2 – Block diagram of the SO₃ regulation feedback loop

loop are denoted with the following symbols: %G, %CL, %FA = percentage of gypsum, clinker and fly ash respectively. %SO₃ = cement sulphates. %SO₃_S, % SO₃_M = SO₃ of the sampled and measured cement correspondingly. %SO₃_T = sulphates target. e = %SO₃_T - %S O₃_M. d = feeders disturbances. n = noise of the SO₃ measurement.

Description of the simulator

Three raw materials contain SO₃: Clinker, gypsum and fly ash. A complete series of analyses has been considered and the mean values and standard deviations of sulphates have been computed to be used in the simulation. When gypsum is changing, pozzolane or limestone is changing simultaneously, depending on the cement type. Therefore, clinker is kept constant for all the cement types and the same for fly ash in CEM IV. An uncertainty of 2 % is assumed for the clinker percentage. The corresponding uncertainty for fly ash is 1 %. The simulator parameters are shown in Table 2. Total run time of the mill, T_{Tot}, equaled 300 hours. The sampling period, T_s, is a simulator parameter ranging from 1 to 4 hours. The delay due to the sampling, analysis, and sending the new setting of gypsum to the mill feeder is T_M = 0.33 h or 20 minutes. The reproducibility of the SO₃ measurement was also included in the simulator. To incorporate disturbances, the following technique is applied: Sulphates and fractions of the three raw materials are kept constant during time intervals computed by normal distribution and random number generator

as follows: Gypsum SO₃ is assumed constant for a time interval T_{Const,G}, not exactly determined, but considered to be within the interval [T_{Min,G}, T_{Max,G}]. Then, by utilizing a random generator, a number, x, between 0 and 1 is selected. To find the interval of constant SO₃ of gypsum, formula (1) is applied.

$$T_{Const,G} = Int \left(\frac{(T_{Max,G} - T_{Min,G} + 1) \cdot x + T_{Min,G}}{1} \right) \quad (1)$$

The calculation of the periods T_{Const,G} is continued until $\sum T_{Const,G} \geq T_{Tot}$. In case this sum is greater, the last T_{Const,G} is truncated to be $\sum T_{Const,G} = T_{Tot}$.

The next step is to determine the SO₃ of gypsum fed during T_{Const,G}. As previously described, a random number, x, belonging to the interval [0, 1] is chosen. Then, the inverse of the normal distribution is applied with probability x, while the values shown in Table 2 are used as SO₃ mean value and standard deviation. Thus, sulphates percentage is found by formula (2).

$$SO_{3,G} = NormalInv(x, SO_{3,Aver}, SO_{3,s}) \quad (2)$$

Exactly the same procedure is followed to find a time interval of CM operation with constant SO₃ of clinker, T_{Const,Cl}, constant SO₃ of fly ash, T_{Const,FA} and SO₃ contents, SO_{3,Cl} and SO_{3,FA} correspondingly. The minimum and maximum time intervals for each raw material used in the simulation are shown in Table 2.

The simulation starts by feeding the mill with a certain cement type having initial gypsum content

Table 2 – Simulation parameters

Material	%SO ₃		Time of constant property in hours		
	Mean	Std. Dev.		Min	Max
Gypsum	40.0	2.0	Gypsum SO ₃	4	16
Clinker	1.40	0.2	Clinker SO ₃	4	8
Fly Ash	1.20	0.5	Fly Ash SO ₃	8	12
%SO ₃ measurement reproducibility		0.05	% Clinker	4	8
Measuring Delay, T _M , (h)		0.33	% Fly Ash	4	8

CEM Type	%Clinker		SO ₃ Target			Str28 _{Max} (MPa)
	Mean	Std. Dev.	Min	Max	Step	
CEM II A-L 42.5 N	80	2	2.0	3.8	0.3	50
CEM II B-M 32.5 N	65	2	1.6	3.4	0.3	38
CEM IV B 32.5 N	52	2	1.5	3.3	0.3	38
%Fly ash of CEM IV	20	1				
Mill run time, T _{Tot} (h)		300				
Number of Iterations		200				

between 3 % and 5 %. This initial percentage is also selected using a random number generator. A sampling period T_s is preselected. In the moments $I \cdot T_s$, where $I = 1$ to T_{Tot}/T_s , spot samples in the outlet of mill circuit are taken and SO_3 is measured. This measurement is introduced to the controller, deriving the new gypsum content, which is transferred to the cement composition at time $I \cdot T_s + T_M$. The procedure continues until time $I \cdot T_s$ equals T_{Tot} . The average and standard deviation of SO_3 over all the cement results are computed. The simulator description implies that the dynamics of sulphates in CM circuit shall be known. Due to the fact that the initial data are generated randomly with respect to some specified limits, for the same initial settings the simulator performs a defined number of iterations. A value of 200 iterations is chosen. Then, the average results of all the runs are computed. In this way, some undesirable noise can be avoided.

Dynamics of SO_3 in the mill circuit

To model the dynamics between SO_3 in CM6 inlet and those of the final product, an industrial experiment has been carried out. During stable operation of the mill, the gypsum was reduced to 2 % for two hours. The gypsum was then increased to 6 %, and simultaneously, high frequency sampling started in the final product stream. Sampling lasted one hour. Thus, the step response of the system had been determined. The experimental points of SO_3 as a function of time are shown in Fig. 3. A first order dynamics with time delay described by eq. (3) fits very well with the experimental data.

$$\frac{SO_3(t) - SO_{3MIN}}{SO_{3MAX} - SO_{3MIN}} = 1 - \exp\left(-\frac{t - T_D}{T_0}\right) \quad (3)$$

where $SO_3(t) = SO_3$ during the transient period, SO_{3MIN} , SO_{3MAX} = the steady state minimum and maximum values of sulphates, T_D , T_0 = the delay time and first order time constant, respectively. The unknown parameters had been identified using Newton – Raphson non-linear regression. Their values are the following: $SO_{3MIN} = 1.69$ %, $SO_{3MAX} = 3.28$ %, $T_D = 0.133$ h, $T_0 = 0.233$ h.

The numerical method used to simulate the SO_3 measurement is based on this dynamical model. The sampling time interval, T_s , is partitioned in minutes and the convolution between SO_3 in CM inlet and the impulse response of the system is computed. To calculate the SO_3 in CM inlet, the simulator takes into account the SO_3 of the raw materials at moment $I \cdot T_s - 1$, determined from equations (1), (2), and the cement composition at moments $I \cdot T_s - 1$ and $I \cdot T_s - 1 + T_M$. Thus, the SO_3 in the grinding circuit outlet is computed in time $I \cdot T_s$, where $I = 1$ to T_{Tot}/T_s . Then an error, following the normal distribu-

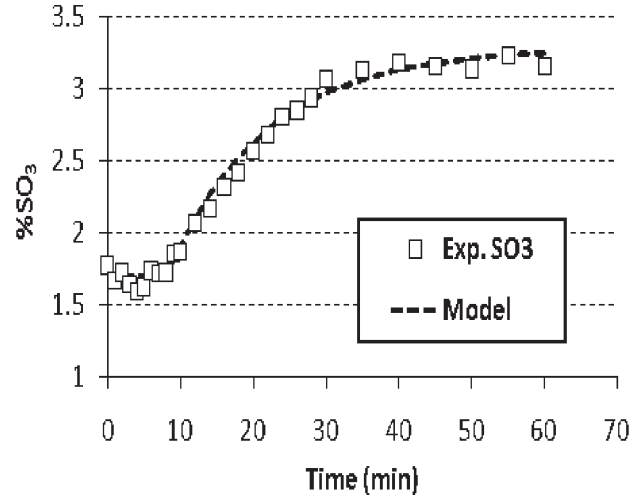

Fig. 3 – Step response of $\%SO_3$ in CM circuit (a) Regulation with step changes controller (b) Regulation with I controller

tion with mean value equal to 0 and standard deviation equal to the measurement reproducibility, is added to simulate the measurement procedure.

Control functions

Two control strategies of different logic are implemented by the simulator. The first one is a controller of step changes (SC), while the second is a traditional proportional-integral (PI) controller. The SC controller is a characteristic example of nonlinear control methodology. If at time I , a measurement $SO_3(I)$ occurs, the error between target and measurement is defined by eq. (4).

$$e(I) = SO_{3,T} - SO_3(I) \quad (4)$$

Then the controller is described by the set of eqs. (5):

$$\begin{aligned} e(I) \in [-a, +a] &\rightarrow DG = 0 \\ e(I) \in [a, 3a] &\rightarrow DG = k \\ e(I) \in [3a, 5a] &\rightarrow DG = 2k \\ e(I) > 5a &\rightarrow DG = 3k \\ e(I) \in [-3a, -a] &\rightarrow DG = -k \\ e(I) \in [-5a, -3a] &\rightarrow DG = -2k \\ e(I) < -5a &\rightarrow DG = -3k \end{aligned} \quad (5)$$

where $2a$ is the length of error interval, and k is the minimum discrete change in gypsum feed. These two variables constitute the parameters set for this kind of controller. With DG the change of gypsum feeder is denoted: If in time I , gypsum content is $G(I)$, then in time $I+1$, $G(I+1) = G(I) + DG$.

The PI controller in digital form is expressed via the much simpler eq. (6):

$$DG = k_p \cdot (e(I) - e(i-1)) + k_i \cdot T_s \cdot e(I) \quad (6)$$

Parameters k_p and k_i represent the proportional and integral gains, respectively, and T_s is the sampling period.

Function between cement SO_3 and compressive strength

The results of Tsamatsoulis⁹ that have been extracted from the same cement types in the same plant and correlate the SO_3/CL ratio with the 28 days compressive strength, $Str28$, were also utilized to investigate the impact of sulphates variance upon the strength variance. The two main equations derived in this study are repeated:

$$\frac{Str28}{Str28_{Max}} = -0.019 \cdot \left(\frac{SO_3}{CL}\right)^2 + 0.14 \cdot \left(\frac{SO_3}{CL}\right) + .73$$

All CEM Types except CEM IV

$$\frac{SO_3}{CL_{Opt}} = 3.7 \quad (7)$$

$$\frac{Str28}{Str28_{Max}} = -0.020 \cdot \left(\frac{SO_3}{CL}\right)^2 + 0.17 \cdot \left(\frac{SO_3}{CL}\right) + .63 \quad (8)$$

CEM IV

where $Str28_{Max}$ is the maximum strength found in the optimum SO_3/CL position expressed in MPa. For the three cement types and the considered clinker content, $Str28_{Max}$ is shown in Table 2. Using functions (7), (8) for each SO_3 value, $str28$ could be computed. Concerning the strength measurement, a 3 % coefficient of variation of measurement reproducibility is assumed. Then the average strength and the linked standard deviation could be determined for each 300 hours operation, as well as for the 200 iterations of this operation.

Initial examples of simulator implementation

Two examples of simulator application are shown in Fig. 4. CEM II B-M 32.5 is chosen with $SO_{3,T} = 2.5$ and sampling period $T_s = 2$ h. In the first application, SC controller is applied with $k = 0.5$ and $\alpha = 0.2$. In the second one, gypsum is regulated with the PI controller with $k_p = 0$, $k_i = 0.8$, therefore with a simple I controller. The results shown in Fig. 4 indicate that the two algorithms behavior differs noticeably: The step changes controller acts when the error is outside of the $[-\alpha, \alpha]$ interval and the changes to the actuator are multiples of k. Conversely, integral controller actions are continuous and the changes are larger or smaller depending on the error magnitude. The results of both controllers for the selected parameterizations are presented in Table 3. The strength is computed using eq. 7. Both

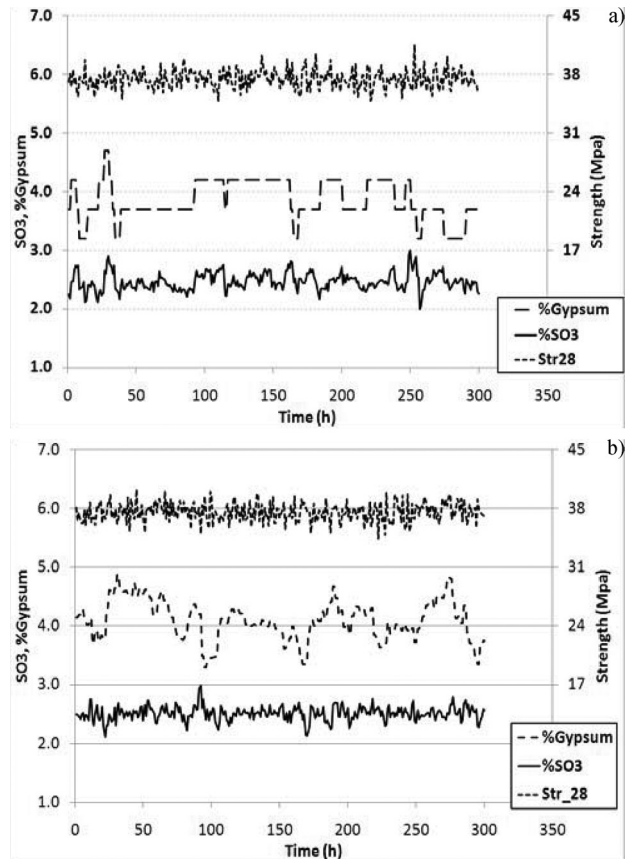

Fig. 4 – Simulation of the gypsum regulation: a) Regulation with step changes controller, b) Regulation with I controller

Table 3 – Results of SC and I controller

	%SO ₃		%Gypsum		Str28 (MPa)	
	Mean	Std.Dev	Mean	Std.Dev	Mean	Std.Dev
SC	2.47	0.15	3.86	0.34	37.5	1.12
I	2.51	0.12	4.10	0.34	37.5	1.12

controllers provide very satisfactory results. A full implementation of the simulator will provide the necessary information for the comparison of the controllers results, their optimization, and their implementation in case of cement type changes.

Implementation of the simulator for one cement type

The simulator is initially implemented for CEM II A-L 42.5 and CEM II B-M 32.5 for the data shown in Table 2. For sampling periods of 1, 2 and 4 hours, both SC and PI controllers are utilized with the following set of parameters:

SC: $\alpha = 0.1, 0.2, 0.3$ and $k = 0.25, 0.5, 0.75$. PI: $k_i = 0.1$ to 1.9 with step = 0.1 and $k_p = 0$ to 1.6 with step 0.4. In the PI controller, the low and high limits are placed to the gypsum dosage. The standard deviation of SO_3 as a function of controller's parame-

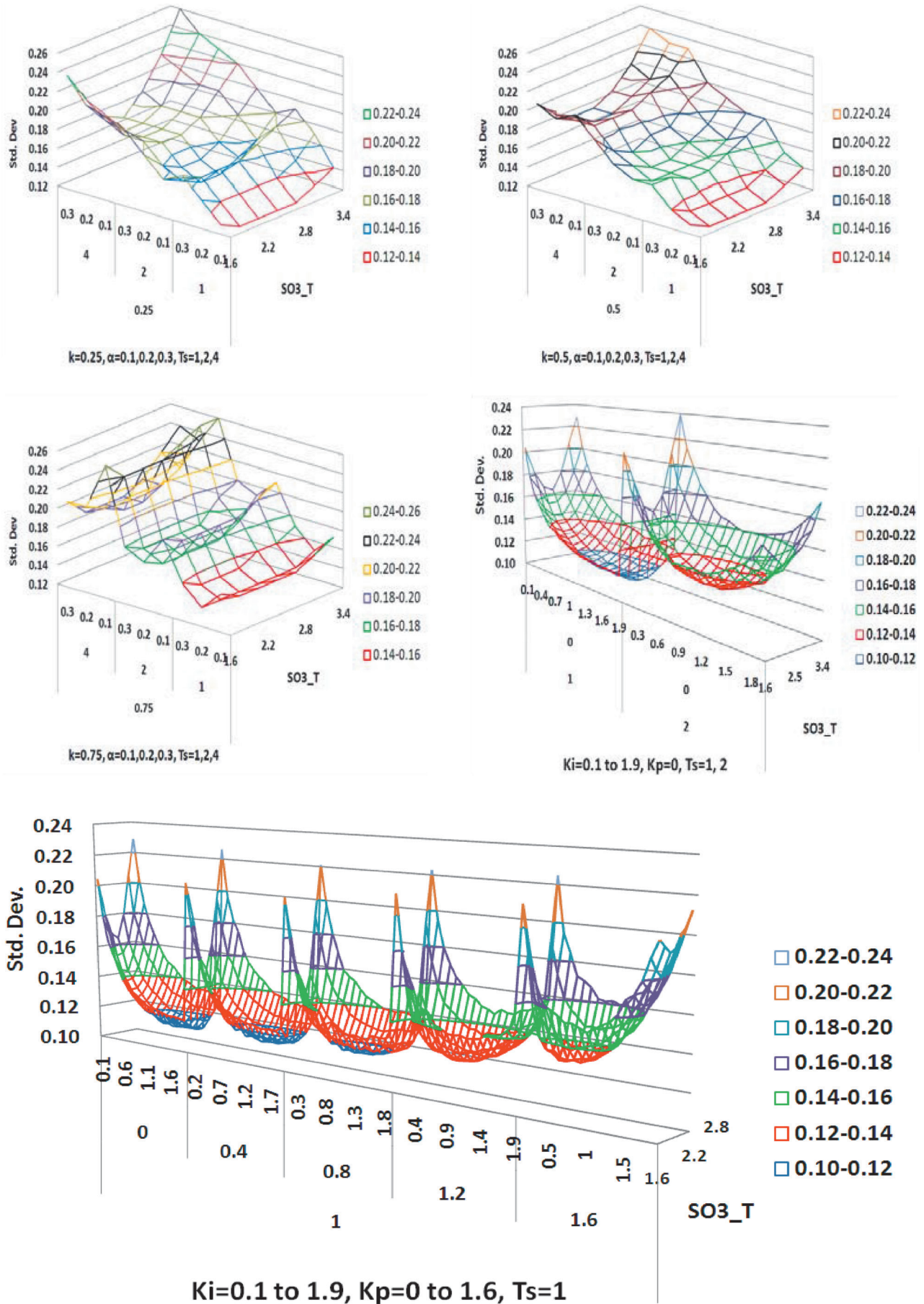

Fig. 5 – Sulphates standard deviation as function of controller's parameters, T_s and $SO_{3,T}$

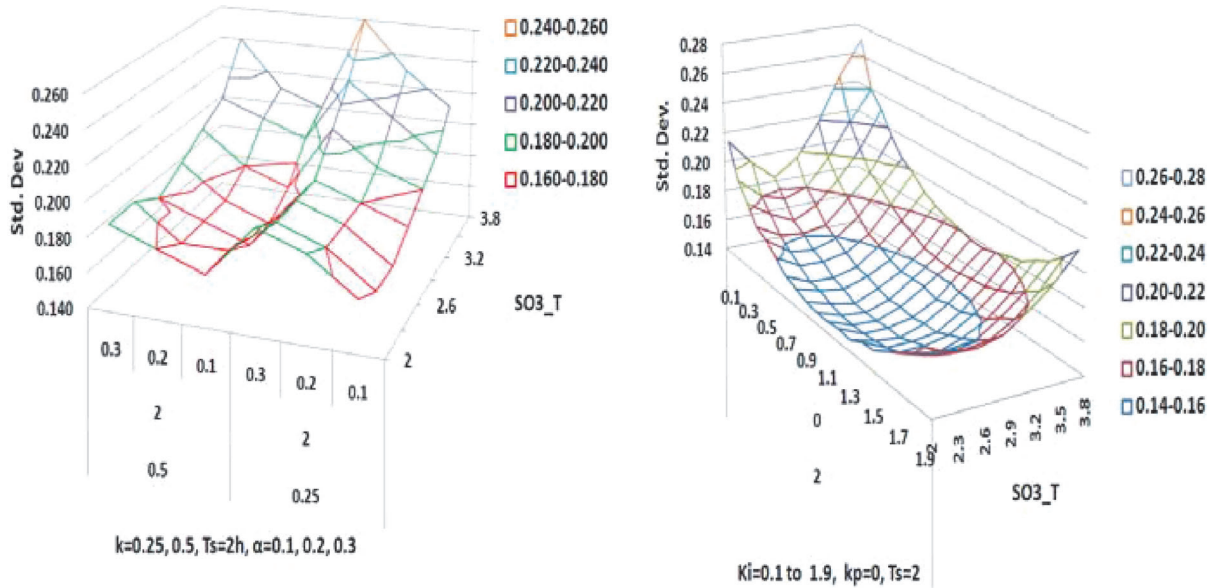

Fig. 6 – Sulphates standard deviation as function of controller’s parameters, T_s and $SO_{3,T}$ for CEM II A-L 42.5

ters, sampling period, T_s and sulphates target $SO_{3,T}$ is shown in Fig. 5 for CEM II B-M 32.5, wherefrom the following conclusions can be derived:

- (i) In both controllers, for the current raw materials, sulphates variance is a function not only of the controller’s parameters and sampling period, but of the $SO_{3,T}$ also.
- (ii) Sulphates targets providing the minimum variance range from 2.2 % to 2.8 % for both regulators. Also noticed is that the optimum SO_3 deriving the maximum strength belongs to interval [2.2, 2.8]. Thus, SO_3 optimum is common for both strength maximization and minimization of sulphates variability.
- (iii) SC controller provides the minimum sulphates standard deviation for $k = 0.25$ and 0.5 , $\alpha = 0.1$ and $T_s = 1$ h. For the settings of Table 2 with the optimum parameters, a standard deviation in the range [0.12, 0.14] is obtained.

(iv) The results of the PI controller indicate that, for the same $SO_{3,T}$ and I part, as P coefficient increases, the standard deviation augments also. Therefore, the optimal controller is simply an I controller.

(v) The minimum standard deviations of the PI controller for $T_s = 2$ h, and of the SC controller for $T_s = 1$ h equally result in the superiority of PI against SC, as with the half sampling actions the same result is achieved. The better results of the PI controller compared with SC are verified also for CEM II A-L 42.5 in Fig. 6: For the same sampling time, PI provides lower optimum standard deviation in comparison with SC.

Optimum integral controllers for SO_3 regulation of CEM IV B 32.5 are shown in Fig. 7. The conclusions derived from the first two CEM types are valid for this type also. From Figs. 5, 6, 7, the optimal integral controllers – the PI with $k_p = 0$ –

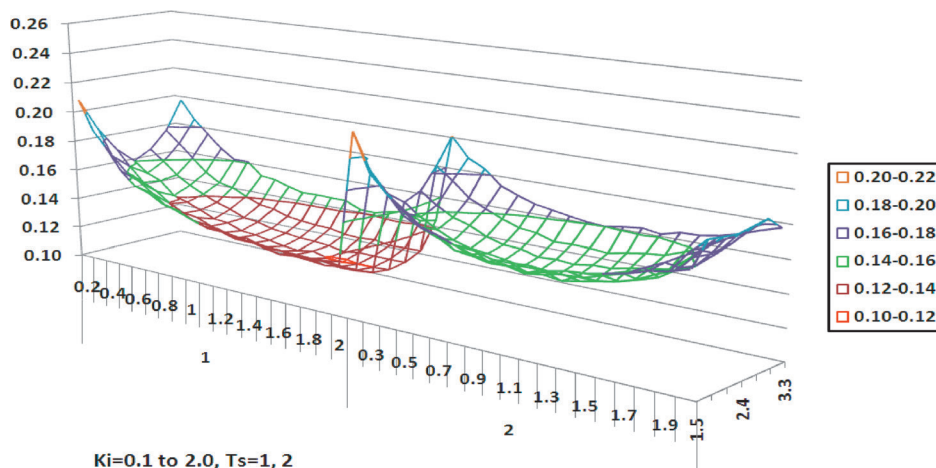

Fig. 7 – Sulphates standard deviation as function of controller’s parameters, T_s and $SO_{3,T}$ for CEM IV B 32.5

Table 4 – Optimum PI controllers

	SO _{3,T}	T _s = 1 h		T _s = 2 h	
		Min k _i	Max k _i	Min k _i	Max k _i
CEM II A-L 42.5 N	2.9	1.1	1.9	0.7	1.5
CEM II B-M 32.5 N	2.5	1.1	1.9	0.7	1.4
CEM IV B 32.5 N	2.4	1.1	2.0	0.6	1.5

are summarized in Table 4 for sampling periods 1 and 2 hours. For each CEM type as an optimum region of controllers is considered the one leading up to a 5 % higher standard deviation from the minimum. The results shown in this table indicate that a common area of controllers exists for all CEM types. For robustness reasons a k_i near to minimum value could be selected to be applied to the actual process control.

Uncertainty analysis

The simulator has been built assuming some uncertainties in the SO₃ content of the cement raw materials, and the time intervals of these sulphates remain constant. These factors influence the stability of the cement SO₃ and their impact should be investigated. In Table 2, the time of constant SO₃ of clinker, T_{Const,Cl} is restricted to vary between two limits T_{Min,Cl} = 4 h and T_{Max,Cl} = 8 h. Similar constraints are assumed for T_{Const,G}. A parametric analysis of the impact of these variables on cement SO₃ has been performed: The variable T_{Const,Cl} belongs to intervals [T_{Min,Cl}, T_{Max,Cl}] = [T_{Aver,Cl}-1, T_{Aver,Cl}+1], where T_{Aver,Cl} increases from 3 h to 16 h with a step of 1 h. Correspondingly, T_{Const,G} varies randomly within intervals [T_{Min,G}, T_{Max,G}] = [T_{Aver,G}-1, T_{Aver,G}+1], where T_{Aver,G} is moving from 3 h to 16 h with a step of 1 h. The other settings have been taken from Table 2. By implementing the simulator for CEM A-L 42.5, the sulphates standard deviations are determined and presented in Fig. 8. From this figure, it is clearly observed that the impact of T_{Aver,Cl} is very strong, much stronger than the impact of T_{Aver,G} on the stability of cement sulphates. Therefore, the higher possible mixing of clinker in a stock silo is of high importance. Usually the mixing is performed by programmed changing of the extracting points at the silo bottom.

To further investigate the influence of raw materials SO₃ uncertainty on the product sulphates, a parametric analysis of clinker and gypsum SO₃ variance has been performed. The simulation is again realized for CEM II A-L 42.5 using all the settings from Table 2, except the SO₃ uncertainty of clinker and gypsum: Clinker standard deviation varies from 0.05 to 0.4 with a step of 0.05, while gypsum standard deviation alters from 1.0 to 5.0 with a

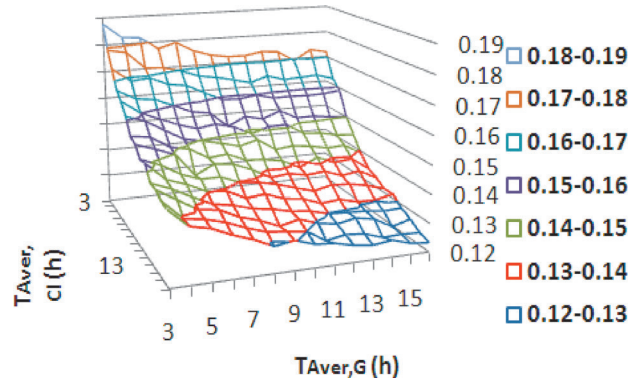

Fig. 8 – SO₃ standard deviation as function of T_{Aver,Cl}, T_{Aver,G}

step of 0.5. In order to normalize the inputs and outputs, the coefficient of variation (CV = 100 × Std. dev. / Average) has been used for the three variables under study – SO₃ standard deviation of clinker, gypsum and cement. The results are presented in Fig. 9 where the high influence of both CV_{SO3,Cl}, CV_{SO3,G} on CV_{SO3,CEM} becomes obvious. Thus, not only does the clinker fed to the mill have to be mixed as best as possible, but in case the plant receives gypsum from different suppliers, one of the two following strategies must be applied: (i) Consumption of one supplier material before the usage of the next, if possible, or (ii) preparation of piles of mixed gypsum by adjusting the proportions of each different gypsum to reach a predefined SO₃ target.

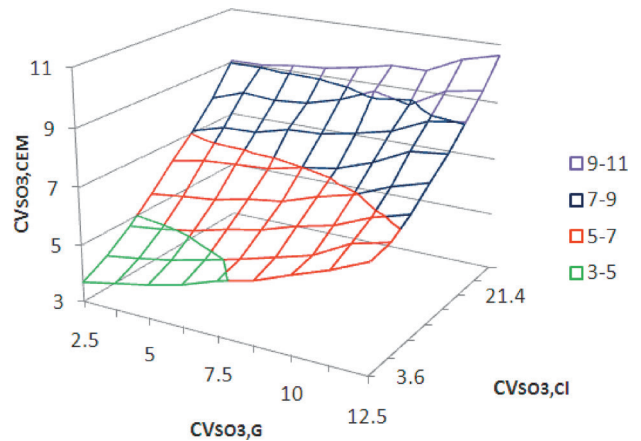

Fig. 9 – CV_{SO3,CEM} as function of CV_{SO3,Cl}, CV_{SO3,G}

Impact of SO₃ target on cement compressive strength

Using the simulator, the 28-day strength has been determined for a large range of SO₃ targets for all CEM types. The simulator operated with the data from Table 2 as concerns all settings except SO_{3,T}, T_s = 2 h and k_i = 0.8. The results are presented in Fig. 10. The high impact of sulphate content on the level of the compressive strength at 28 days becomes clear.

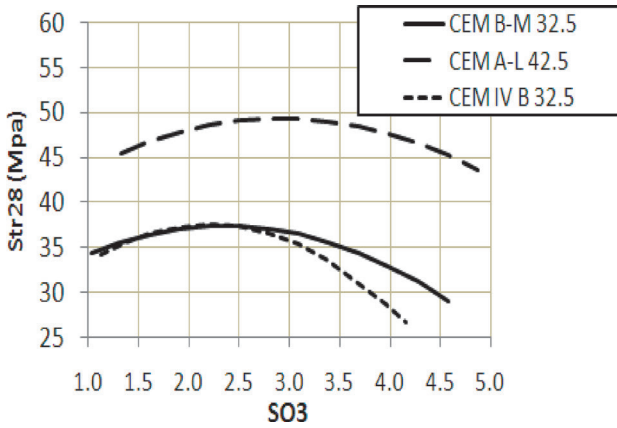

Fig. 10 – Strength at 28 days as function of SO₃ level

From these results, an optimum SO_{3,T} range could be determined assuming that strength is to be maintained in a zone 0.5 % around the maximum. The optimum range results are indicated in Table 5.

Table 5 – Range of SO_{3,T}

	Optimum SO _{3,T}	
	Min	Max
CEM II A-L 42.5 N	2.5	3.1
CEM II B-M 32.5 N	2.2	2.8
CEM IV B 32.5 N	1.9	2.5

Implementation of the simulator for multiple cement types

To approach actual plant conditions better, further development of the simulator is necessary: The simulation and optimization of the action system control to be taken when the cement type changes. The above has an impact on the SO₃ variance per CEM type, due to the fact that for each type another SO_{3,T} exists. Therefore, some additional rules and functions have been added to cope with this situation. A total run time of the mill equal to 600 hours is assumed. Cement mill operates with certain cement type for a time interval T_{Const,CEM}, considered to be between T_{Min,CEM} and T_{Max,CEM}. By utilizing a random generator and eq. (1) T_{Const,CEM} is determined. The cement type is selected randomly between the three. When T_{Const,CEM} expires, a next selection of CEM type is performed and a new time interval is determined. The procedure continues until the cumulative milling time becomes equal to or greater than the total run time. When the type changes at a time I, the gypsum changes according to the following rules:

$$SO_{3,N} = (SO_{3,P} + (Cl_{CEM,N} - Cl_{CEM,P}) \cdot SO_{3,Cl} + (Ash_{CEM,N} - Ash_{CEM,P}) \cdot SO_{3,Ash}) \cdot \frac{100}{SO_{3,G}} \quad (9)$$

$$DG = K_{ch} \cdot (SO_{3,T} - SO_{3,N}) \quad (10)$$

$$Gypse_N = Gypse_P + DG \quad (11)$$

where SO_{3,P} is the SO₃ measured at time I, Cl_{CEM,P}, Cl_{CEM,N}, Ash_{CEM,P}, Ash_{CEM,N} are the average clinker and fly ash contents of the previous and new CEM type, respectively, SO_{3,Cl}, SO_{3,Ash} and SO_{3,G} are the average SO₃ content of clinker, fly ash and gypsum correspondingly. Function (9) derives SO_{3,N}. DG is the gypsum change, K_{ch} is a gain factor multiplying the error and needs to be identified/optimized for a given mill, Gypse_P is the gypsum percentage applied from time I-1 to I, while Gypse_N is the new gypsum setting to be placed in the feeder. An example of application of the simulator is presented in Fig. 11. The following settings are utilized: Controller with k_i = 0.8, T_{Min,CEM} = 12 h, T_{Max,CEM} = 16 h, K_{ch} = 0. The SO₃ targets are 2.8 % for CEM II A-L 42.5, 2.5 % for CEM II B-M 32.5 and 2.4 % for CEM IV B 32.5.

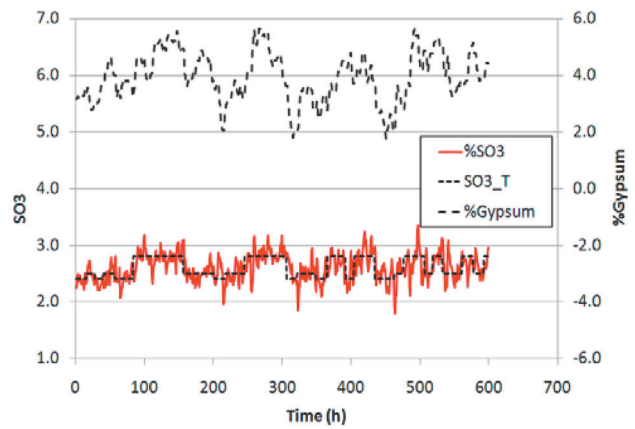

Fig. 11 – Simulation of the gypsum regulation for three CEM types

Gain Factor Optimization

The gain K_{ch} is a parameter needing optimization: If K_{ch} = 0, then the type change is not taken into account. As K_{ch} increases, the clinker and ash contents of previous and next type contribute more to the resulting action. For the gypsum computed from (11) two cases are considered:

(i) Gypse_N is unconstrained

(ii) Gypse_{Min} ≤ Gypse_N ≤ Gypse_{Max}. The low and high limits are defined for each CEM Type according to the average SO₃ of raw materials and margins of ± 0.5 %.

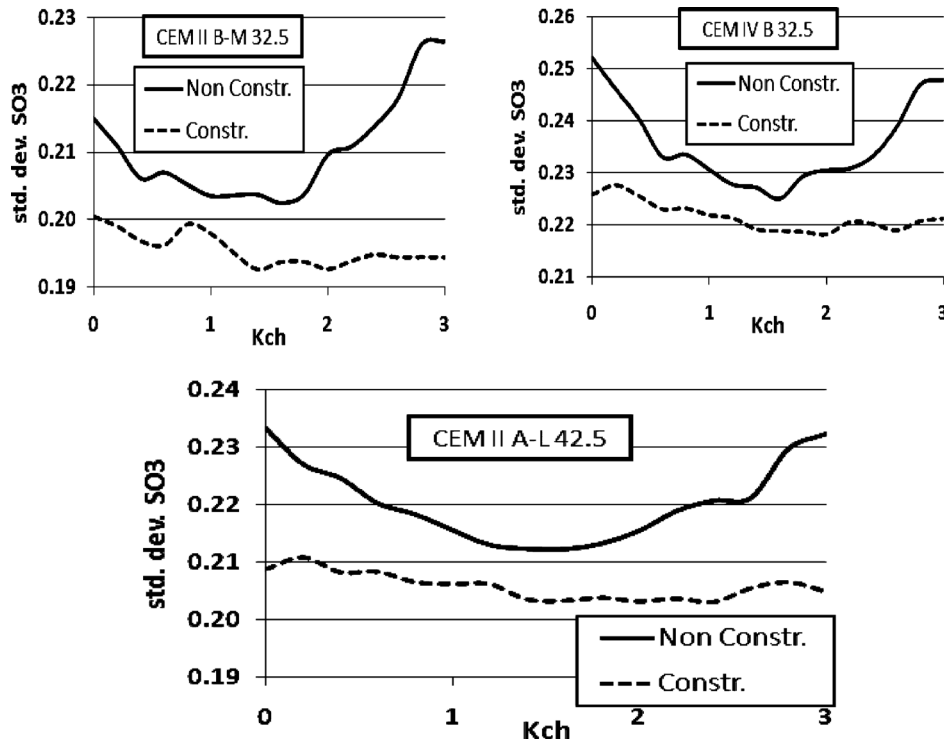

Fig. 12 – Sulphates standard deviation as function of K_{ch} for unconstrained and constrained cases

The simulation has been applied for 600 hours of operation and $T_{Min,CEM} = 8$ h, $T_{Max,CEM} = 12$ h, $T_s = 2$ h. All the other settings correspond to the values in Table 2. Gains from 0 to 3 with a step of 0.2 are studied. The results are shown in Fig. 12 for unconstrained and constrained action in the gypsum when the cement types changes.

A distinguishable optimum K_{ch} exists in the case the action in the gypsum feeder is unconstrained. In all three CEM types, this optimum is located in a position slightly higher than $K_{ch} = 1$. The constrained action derives noticeably improved standard deviations than the unconstrained one. Therefore, a constrained action with $K_{ch} = 1$ and saturation limits defined from the average SO₃ of raw materials and margins ± 0.5 % could be regarded as the optimum rule, when CEM type is changing.

Effect of sampling period and number of changes of CEM type on SO₃ variance

Normally, the higher the number of type’s changes during a certain time interval, the higher is the variance of SO₃ of each cement type. On the other hand, as the sampling period decreases, SO₃ becomes more homogeneous. To investigate the impact of these two factors on SO₃ uniformity, the simulator is applied as follows: For a total grinding duration of 600 h, parameters $T_{Min,CEM}$, $T_{Max,CEM}$ have been varied from minimum to maximum values by keeping a constant difference of 4 hours

between them. Thus, for the average grinding time of a CEM type, the following formulae are applied:

$$T_{Max,CEM} - T_{Min,CEM} = 4 \tag{12}$$

$$T_{Aver,CEM} = \frac{T_{Max,CEM} + T_{Min,CEM}}{2} \tag{13}$$

An optimum controller is applied with $k_i = 0.8$. The change of type follows the optimum rule defined in the previous section with $K_{ch} = 1$ and saturation limits of minimum and maximum gypsum. The standard deviations of SO₃ for the three CEM types as function of $T_{Aver,CEM}$ and sampling period, are shown in Fig. 13. It can be clearly observed that frequent changes of CEM type result in a noticeable deterioration of SO₃ standard deviation. The reduction in sampling period from $T_s = 2$ h to $T_s = 1$ h cannot compensate this worsening drastically despite that a cost of double analysis frequency is paid. Consequently, the more the cement mills of a plant are dedicated in producing one type of cement, the better is the consistency of sulphates.

Implementation of the two controllers in industrial milling conditions

Both SC and PI controllers have been placed in operation in CM6 of Halyps plant and long term results of control have been reviewed. The same CEM types analysed are also actually milled. In the

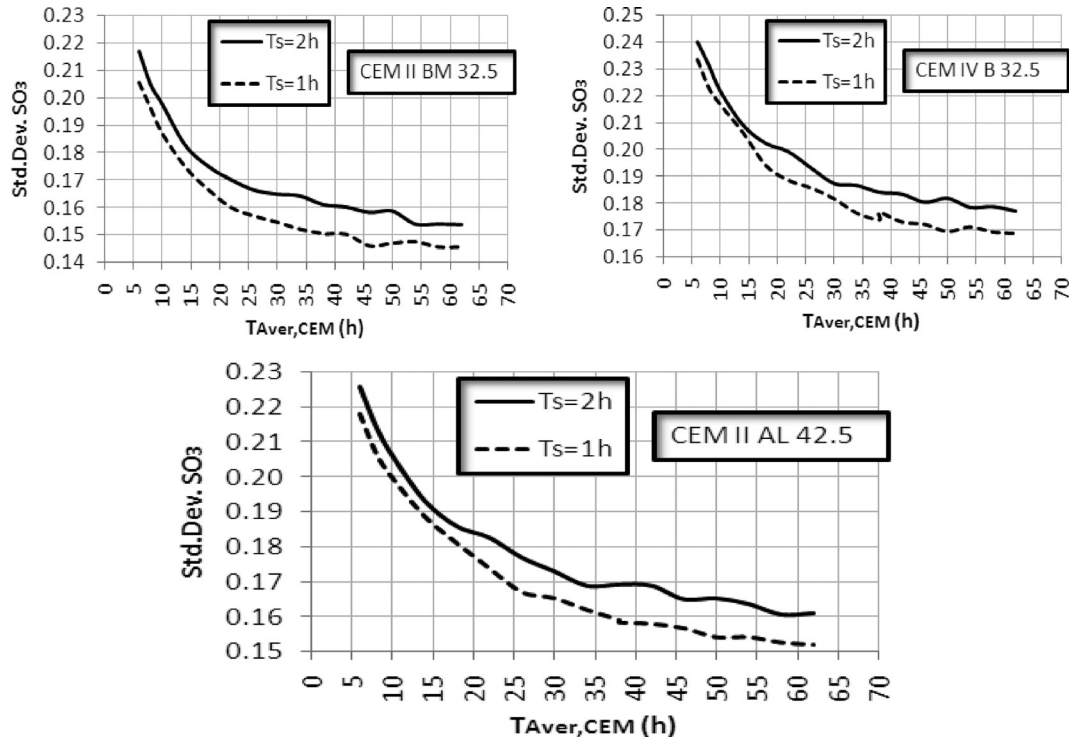

Fig. 13 – Sulphates standard deviation as function of $T_{Aver,CEM}$ and T_s

case of types' change, during SC operation the optimized feedforward action has not been applied but the immediate action on the gypsum content was based on the working experience. Operating data and controller settings are demonstrated in Table 6. The parameters of SC controller belong to optimum or suboptimum region for all three CEM types, while PI controller continuously operates in the optimal parameters area. In the PI case, the average time of uninterrupted grinding of CEM II A-L 42.5 is higher than the respective value when SC works at 17 % (= 35/30–1). For the two other types, during PI operation, the periods $T_{Aver,CEM}$ are shorter than those of SC at 36 % and 32 %. Therefore, on average and according to Fig. 13, the operating conditions during PI working are worse than those of SC.

During the production of the mentioned types, not only spot measurements of SO₃ are performed but also a daily sample per CEM type is prepared, composed from the spot samples. Chemical analysis is also executed to these average daily samples. Thus, two criteria of performance of the two controllers are to be utilized for each CEM type: The standard deviation of SO₃ in the spot samples population and the one in the population of the average samples. The coefficients of variation could also be used as additional criteria. The comparison of the performance is demonstrated in Table 7. From these results, the superiority of the PI controller against SC becomes clear. In all the three types, the SO₃ standard deviation of both spot and average samples

improved considerably: In the spot samples, the ratio of two deviations is from 64 % to 86 %, while in the daily samples noticeably less, from 36 % to 76 %. The above result occurs despite the reduction in Table 6 – *Operating data and controllers settings*

SC controller					
	SO _{3,T}	T _s (h)	T _{Aver,CEM} (h)	T _{Tot} (h)	1034
CEM II A-L 42.5	2.8	2	30		SC parameters
CEM II B-M 32.5	2.5	2	22		<i>a</i> 0.2
CEM IV B 32.5	2.4	4	22		<i>k</i> 0.5
PI controller					
	T _{Tot} (h)		1374		Feedforward Settings
	SO _{3,T}	T _s (h)	T _{Aver,CEM} (h)	Gypse _{Min}	Gypse _{Max}
CEM II A-L 42.5	2.8	2	35	3.9	4.9
CEM II B-M 32.5	2.5	2	14	3.8	4.8
CEM IV B 32.5	2.4	2	15	3.1	4.1
Feedback PI parameters				K _{ch}	1
<i>k_p</i>	0	<i>k_i</i>	0.8		

average grinding time in CEM II BM and CEM IV B. The big improvement in the case of CEM IV B could be also partially attributed to the decrease in the sampling period. The large magnitude of standard deviation reduction in the average daily sam-

Table 7 – Evaluation of controllers performance

	CEM II A-L 42.5	CEM II B-M 32.5	CEM IV B 32.5
SC Controller – Spot samples			
Average SO_3	2.83	2.51	2.45
Std. Dev.	0.179	0.183	0.294
%CV	6.3	7.3	12.0
SC Controller – Average daily samples			
Average SO_3	2.82	2.50	2.58
Std. Dev.	0.12	0.11	0.16
%CV	4.3	4.4	6.2
PI Controller – Spot samples			
Average SO_3	2.81	2.48	2.44
Std. Dev.	0.144	0.157	0.188
%CV	5.1	6.3	7.7
PI Controller – Average daily samples			
Average SO_3	2.81	2.48	2.44
Std. Dev.	0.050	0.083	0.057
%CV	1.8	3.4	2.3
% Ratio Std.Dev PI/ Std.Dev SC			
Spot samples	80.2	85.9	64.0
Daily samples	42.0	75.7	35.6

ples results from the fact that average daily SO_3 is very near to the target. Therefore, the PI feedback controller, combined with the feedforward part, constitutes a strong tool of cement quality improvement.

Conclusions

The control of grinding process regarding the SO_3 content in an industrial mill has been effectively simulated taking into account all its fundamental sides and particularities: (1) Analyses of the raw materials and their uncertainty; (2) CM dynamics; (3) sampling period and measuring delays; (4) measurement reproducibility; (5) cement composition and feeders accuracy; (6) variability of raw materials SO_3 during grinding; (7) grinding of various CEM types in the same CM with different sulphates targets; (8) function between SO_3 and typical compressive strength. Based on the simulator, two controllers of different philosophy have been studied: A classical PI controller as well as a nonlinear one (SC) consisting of a dead band of SO_3 equal to 2α and step changes of gypsum feed with gain k or a multiple of k . Initially, the simulator was imple-

mented in a single cement type and the two controllers were compared using SO_3 standard deviation as criterion of product regularity. The operation with three different CEM types was investigated. Both controllers provided very satisfactory SO_3 consistency but PI was more efficient against SC as with the double sampling period, the same minimum standard deviation was obtained leading to the same result with half the sampling actions. Using the simulation, the gains of the PI controller were optimized concluding that a simple integral controller was adequate to achieve the minimum SO_3 standard deviation. For all CEM types the optimal interval of k_i was determined. An integral gain belonging to the common region among the three could be selected to be placed in actual operation. For robustness reasons, a value near the minimum gain should be chosen. The target of SO_3 and the uncertainty of raw materials sulphates play a crucial role in the consistency of products. The mixing of each raw material before consumption contributes to the reduction in the resulting standard deviations. Additionally, the SO_3 optimal interval to obtain the maximum 28-day compressive strength is the same with the one leading to optimum SO_3 uniformity. Thus, the proper selection of the target optimizes both strength and variability.

The simulator was also implemented for milling of several cement types. Some additional optimization was necessary when the type changed. In this case, two changes occurred: Sulphates target was modified and due to the different composition the SO_3 fed to the mill also differed. A new setting of gypsum had to be placed immediately according to the new data before a new measurement. This action could be characterized as a feedforward controller. An optimum constrained solution was determined by optimizing a gain factor and imposing saturation lower and upper limits for the new gypsum percentage. By applying the optimized feedback controller linked with the feedforward part, the impact of sampling period and of the number of changes of CEM type on the SO_3 variability was investigated. If the number of changes becomes more frequent, then a decrease in sampling period is not enough to compensate effectively the deterioration of SO_3 uniformity. Thus, as long as a CM is dedicated to produce a certain cement type, the sulphates variability is so much lower.

Both controllers were placed in operation in an industrial grinding circuit. The PI feedback controller combined with the feedforward part produces significantly lower sulphates variability, compared with the SC controller. Therefore, the installation and function of this kind of controller in industrial milling systems contributes greatly to the improvement of cement quality.

Nomenclature

C_3A	– Tricalcium aluminate, %
Cl, %CL	– Clinker content, %
d	– Disturbance
DG	– Change of gypsum feeder, %
e	– Error between $SO_{3,T}$ and SO_3 , %
%FA, Ash	– Fly ash content, %
GC	– Controller transfer function
GM	– Measurement transfer function
GP	– Materials mixing transfer function
GS	– Sampling transfer function
G, %G	– Gypsum content, %
n	– Noise
k	– SC controller gain
K_{ch}	– Gain factor in eq. (10)
k_i	– Integral gain of PID controller
k_p	– Proportional gain of PID controller
R	– Regression coefficient
SO_3	– Sulphates content, %
$SO_{3,Aver}$	– Mean value of SO_3 , %
% SO_3_M	– % SO_3 after measurement, %
% SO_3_S	– % SO_3 after sampling, %
$SO_{3,s}$	– Standard deviation of SO_3 , %
% SO_3_T , $SO_{3,T}$	– SO_3 target, %
SO_3/CL	– Mass ratio between SO_3 and clinker content, %
Str28	– Compressive strength at 28 days, MPa
t	– Time, 3600 · s
T_0	– First order time constant, 3600 · s
T_{Aver}	– Average time, 3600 · s
T_D	– Delay time, 3600 · s
$T_{Const,CEM}$	– Time with constant CEM type, 3600 · s
$T_{Const,Cl}$	– Time with clinker of constant SO_3 , 3600 · s
$T_{Const,G}$	– Time with gypsum of constant SO_3 , 3600 · s
T_M	– Measuring delay time, 3600 · s
T_s	– Sampling period, 3600 · s
T_{tot}	– Period of simulator operation, 3600 · s
x	– Random number between 0 and 1

Greek symbols

2a – length of error interval

Subscripts

Min	– minimum value
Max	– maximum value
N	– next
Opt	– value of independent variable where optimum exists
P	– previous

Abbreviations

CEM	– cement type
CM	– cement mill
PID	– proportional integral derivative controller
PI	– proportional and integral controller
SC	– controller of step changes

References

1. Lee, F. M., *The Chemistry of Cement and Concrete*, 3rd ed. Chemical Publishing Company Inc., New York, 1971.
2. Bogue, R. H., *The Chemistry of the Portland Cement*, Reinhold Publishing Corporation, Second Edition, London, 1955.
3. Lerch, W., *Proceedings of the American Society for Testing Materials* **46** (1946) 1252.
4. Soroka, I., Abayneh, M., *Cem. Concr. Res.* **16** (1986) 495.
5. Jansen, D., Goetz-Neunhoffer, F., Stabler, C., Neubauer, J., *Cem. Concr. Res.* **41** (2011) 602.
6. Jansen, D., Goetz-Neunhoffer, F., Lothenbach, B., Neubauer, J., *Cem. Concr. Res.* **42** (2012) 134.
7. Yamashita, H., Yamada, K., Hirao, H., Hoshino, S., *Concrete Research and Technology* **18** (2007).
8. Lothenbach, B., Le Saout, G., Gallucci, E., Scrivener, K., *Cem. Concr. Res.* **38** (2008) 848.
9. Tsamatsoulis, D., Nikolakakos, N., *Chem. Biochem. Eng. Q.* **27** (2013) 133.
10. Odler, I., *Mater. Struct.* **24** (1991) 143.
11. Kheder, G. F., Gabban, A. M., Abid, S. M., *Mater. Struct.* **36** (2003) 693.
12. Dhanjal, S. K., Young, L., Storer, P., *Automatic control of cement quality using on-line XRD*, Piscataway, N. J. (Ed.), *Proceedings of Cement Industry Technical Conference*, Conference Record IEEE, Phoenix, Arizona, 2006, IEEE Operations Center, pp. 17–24.
13. Efe, M. O., *Trans. Inst. Meas. Control* **25** (2003) 373.